

Hardware Software Co-Design and Testing Using Simulink® Real-Time™

Paul Berry and Brian Steenson



Process Development

- Introduction to THALES
- Overview of design process
- Development of autocode capability

Real Time Testing for the Lightweight Multirole Missile

- Guidance and control algorithm design
- Guidance and control algorithm implementation
- Guidance and control algorithm testing

THALES in the UK



Aerospace

Avionics Systems
Air Traffic Management
In-Flight Entertainment
Electrical Systems
Training and Simulation



Defence

Radar
Watchkeeper
Command and Control
Cameras and Sensors
Sonar Systems
Threat Warning
Short Range Defence



Ground Transportation

Signalling Systems
Integrated Comms & Supervision Systems
Revenue Collection Systems



Security

Secure Communication
Network & Infrastructure Systems
Protection Systems
Critical Information Systems & Cybersecurity



Space

Telecoms
Observation
Infrastructure
Navigation

OPEN

THALES

THALES in Belfast

This document may not be reproduced, modified, adapted, published, translated, in any way, in whole or in part or disclosed to a third party without the prior written consent of Thales - © Thales 2017 All rights reserved.



1962
SEACAT



1967
TIGERCAT



1975
BLOWPIPE



1984
JAVELIN



1989
STARBURST



1997
STARSTREAK (HVM)



1996 - 2002
HELLFIRE



2001
VT1



2002
NLAW



2008
Stormer SP



2008
RAPIDRanger



2009
FASGW



2011
LMM



2014
ForceSHIELD



2015
LML NG

OPEN

THALES

Effectors



Platforms



Space



Model Based Algorithm Development

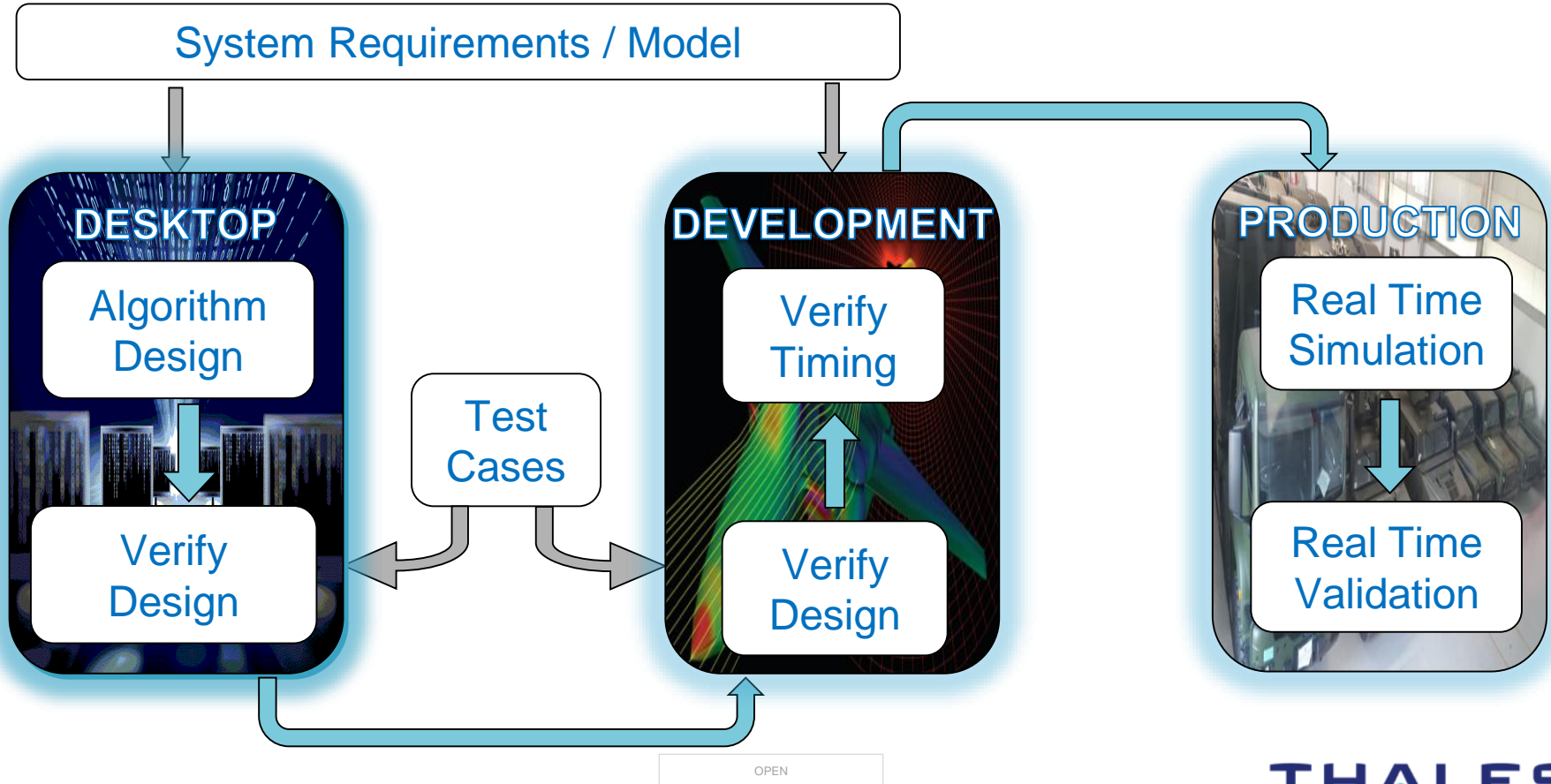

This document may not be reproduced, modified, adapted, published, translated, in any way, in whole or in part or disclosed to a third party without the prior written consent of Thales - © Thales 2017 All rights reserved.

Model Based Algorithm Development

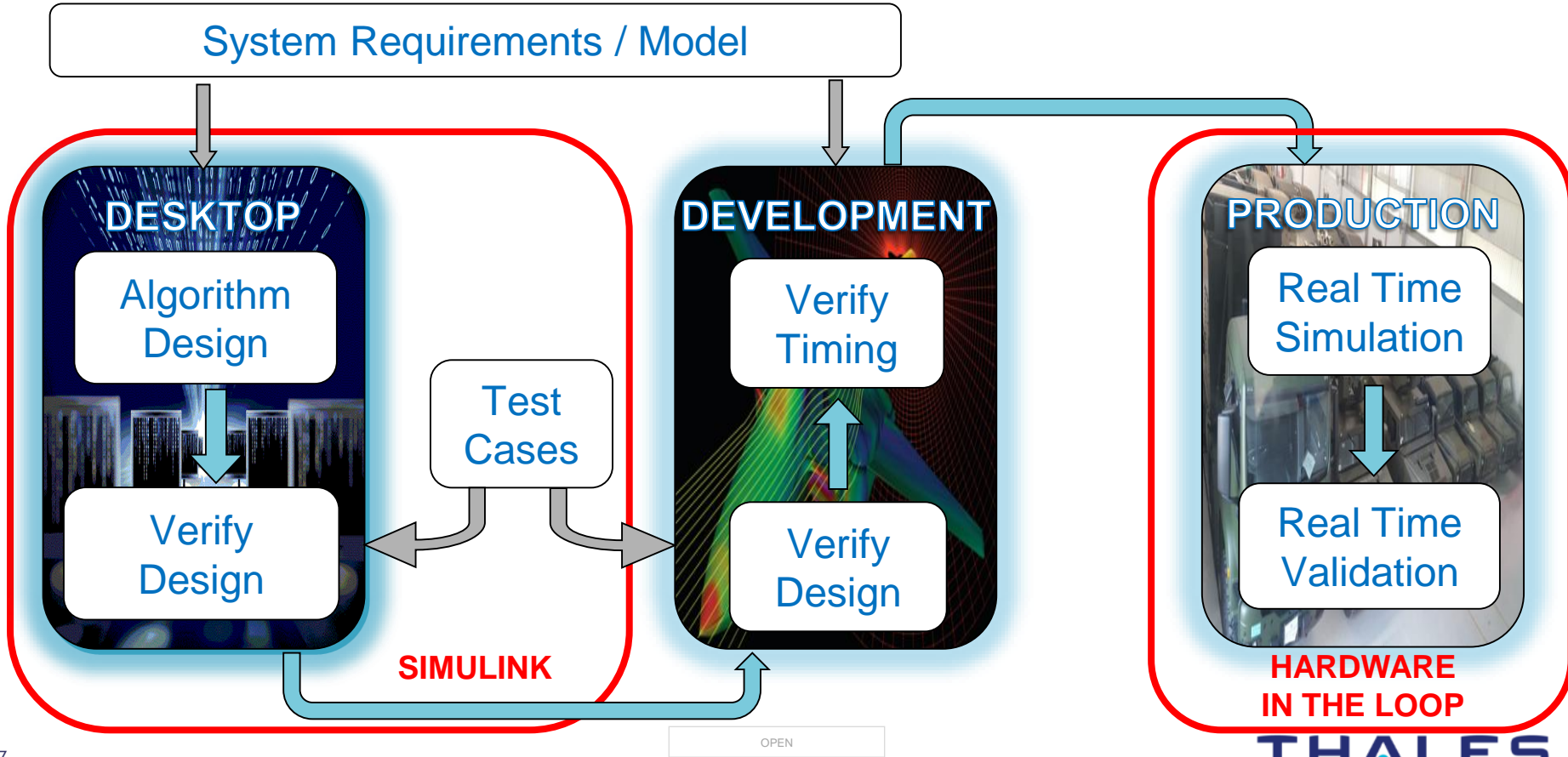

This document may not be reproduced, modified, adapted, published, translated, in any way, in whole or in part or disclosed to a third party without the prior written consent of Thales - © Thales 2017 All rights reserved.

Goals and Objectives

- Remove human error
- Reduced code development time
- Early prototype on hardware
- Improved efficiency
- Fast turn around between iterations
- Common test environment
- Improved traceability

OPEN

Evolution of Autocoding Capability

2005: Land Based Systems

- Algorithm development for target tracking algorithm
- Implemented in C from Simulink
- Floating point C code



2007: Missile Systems

- Guidance algorithm implemented in C from Simulink
- Target-specific libraries used to optimise speed
- Fixed point C code



Evolution of Autocoding Capability

2009: Hardware/Software Partitioning

- Motor control algorithms developed in Simulink
- Autogenerated C code used to quickly prove concept
- Final solution partitioned between C and HDL

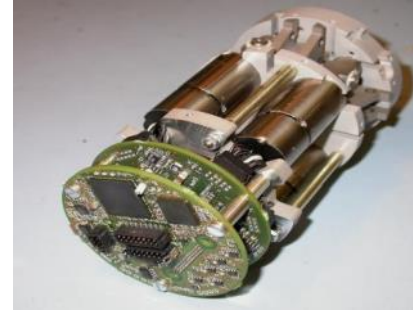

2013: FreeFall-LMM rapid development

- Rapid prototyping of guidance and control algorithms
- Autogenerated C code
- 6 months development from concept to flight trials



Evolution of Autocoding Capability

2017: Next Generation Beam Steering

- Updated algorithms developed for new guidance unit
- μ rad positional accuracy and stabilisation error
- Autocoded algorithms ported to System on Chip
- Improved linkages between model and implementation

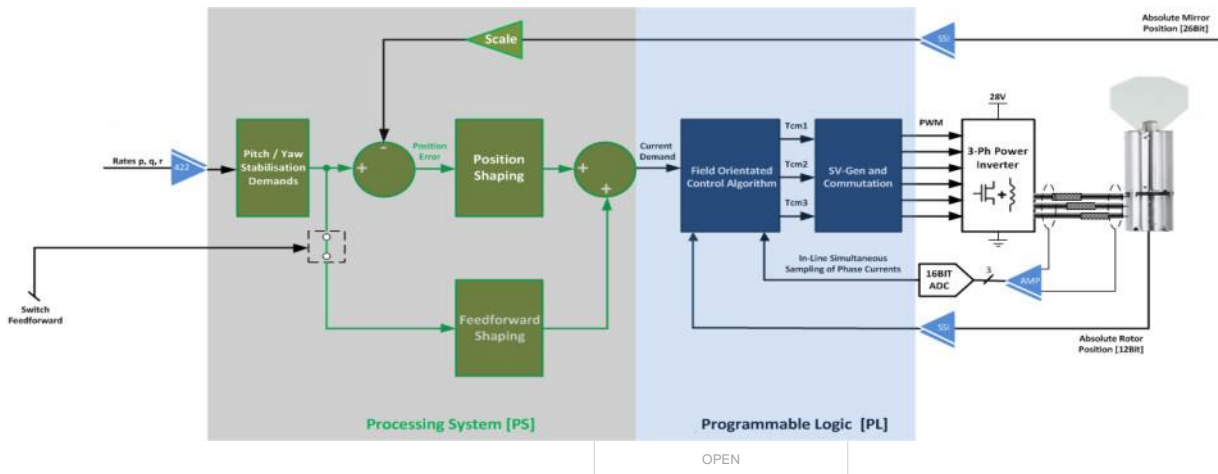

Evolution of Autocoding Capability – Future?

Missile state machines

- Currently using legacy state machine layer
- Bring this logic within MBD process as complexity increases

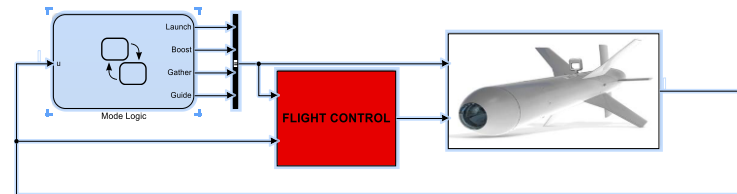

Digital laser scanning

- Very high rate (ns), high precision control
- High fidelity simulation crucial to understanding
- MBD approach essential for rapid prototyping and implementation

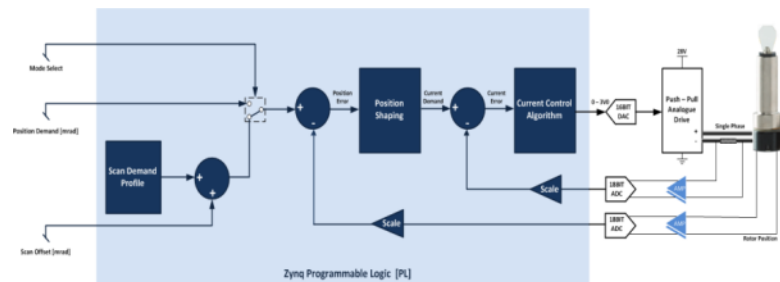

THALES



Real Time Testing for the Lightweight Multirole Missile

www.thalesgroup.com



LMM launch

This document may not be reproduced, modified, adapted, published, translated, in any way, in whole or in part or disclosed to a third party without the prior written consent of Thales - © Thales 2017 All rights reserved.



OPEN

Guidance and control algorithm design

- (Sub)system model development
- Algorithm development
- Performance verification in non-real time Simulink 6DOF simulation
- Generate algorithm autocode (C or HDL)

Guidance and control algorithm testing

- Real time simulator development
 - Real time 6DOF simulation
 - Hardware emulators
- Hardware in the Loop testing
- Verification and Validation

OPEN

Develop subsystem models:

- Aerodynamics
- Structural bending
- Inertial Measurement Unit (IMU)
- Laser Information Field (LIF)
- Semi-Active laser (SAL)
- Control Actuation System (CAS)
- Rocket motor(s)
- Missile dynamics
- Canister exit model
- Launch platform
- Guidance algorithms

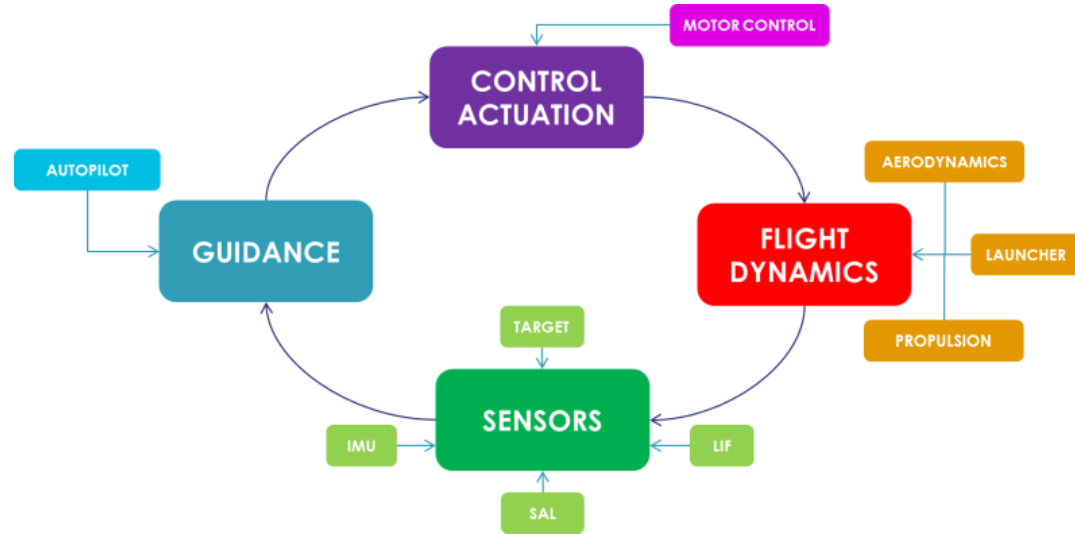
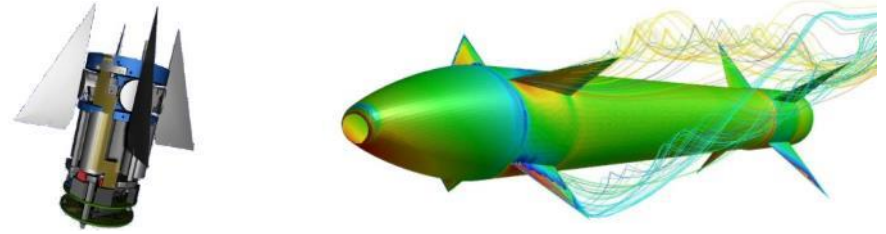

OPEN

Guidance algorithm design

- Controllers developed at key operating points
- Based on a continuous linearised/idealised model
- Algorithm design iteration may be required
- Discrete versions of algorithms created
- Performance quantified in 6DOF simulation
- Iteration may be needed

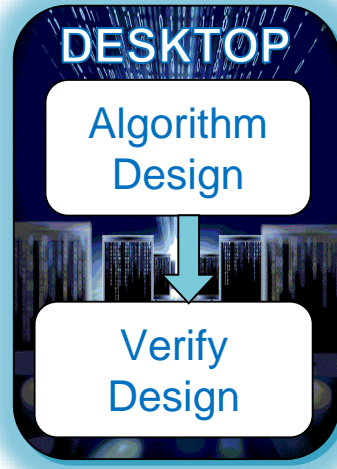
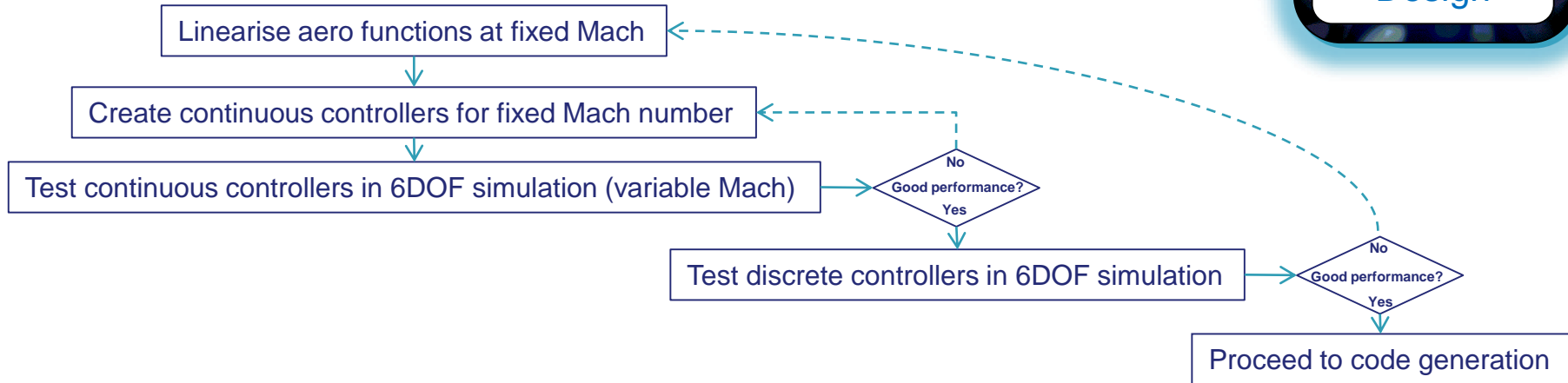

OPEN

Testing in non-real time - Simulink 6DOF Simulation

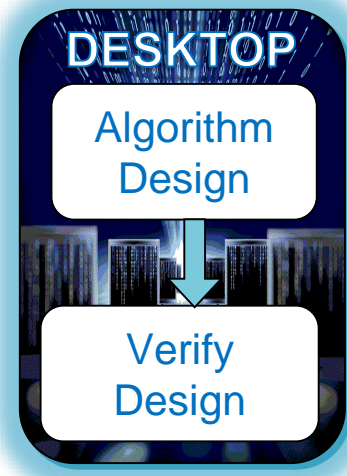
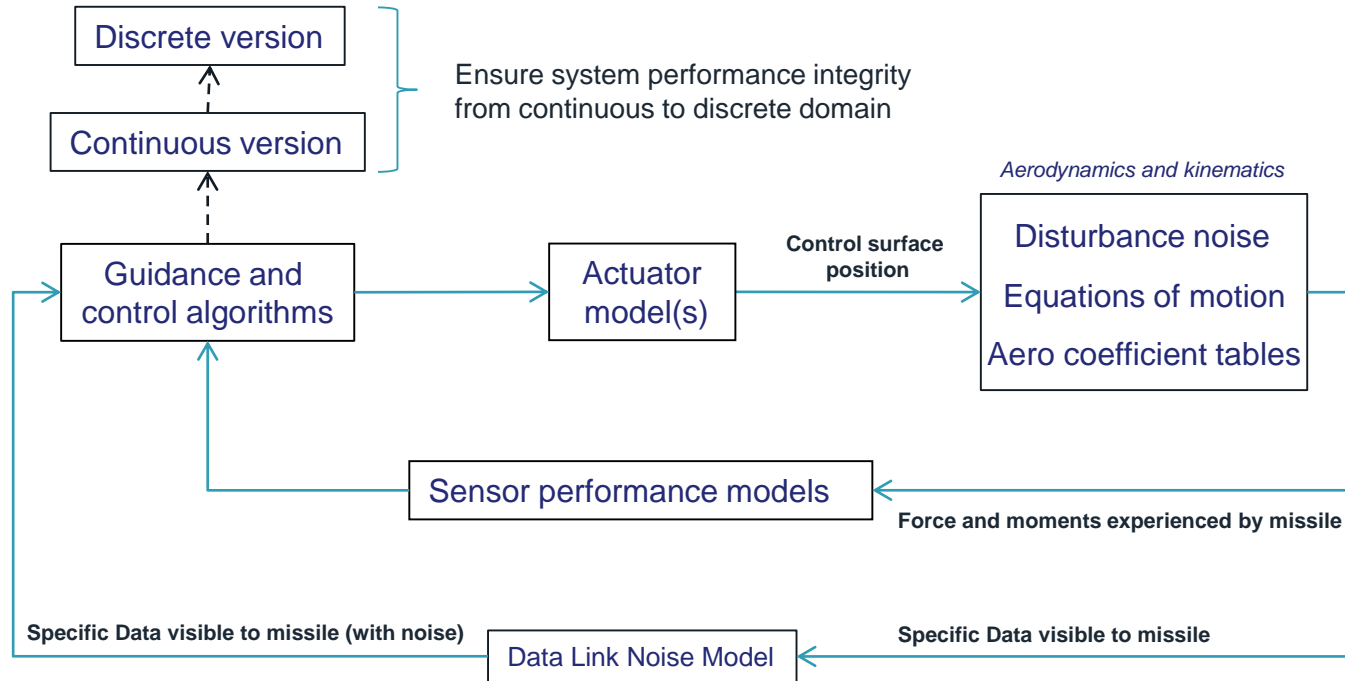

This document may not be reproduced, modified, adapted, published, translated, in any way, in whole or in part or disclosed to a third party without the prior written consent of Thales - © Thales 2017 All rights reserved.

Autocode algorithms onto target - C

- Common autocode configuration settings across projects for code standard consistency
- Run Monte Carlo simulations replacing algorithms with autogenerated code
- Open loop tests using 6DOF generated test vectors performed on target hardware
- Verify executable code integrity and assess coverage

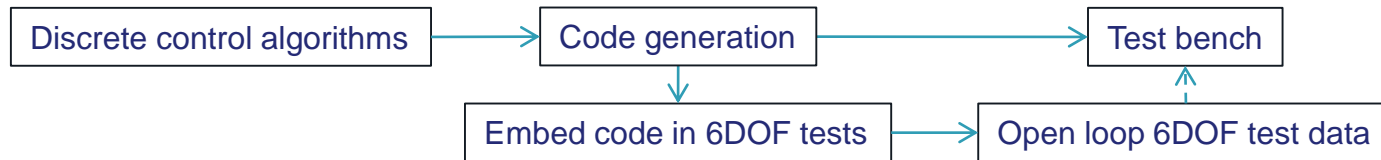

OPEN

Autocode algorithms onto target - HDL

- Common autocode configuration settings across projects for code standard consistency
- Fixed point model required
- Open loop tests using 6DOF generated test vectors performed on target hardware
- Check executable code integrity and assess coverage

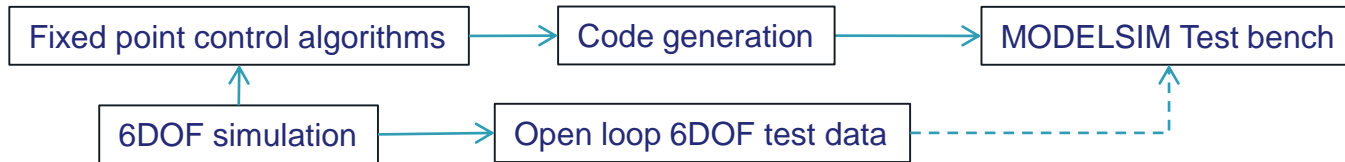
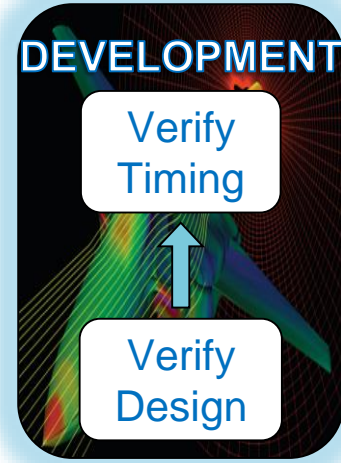

OPEN

LMM Laser Beam Riding (LBR) HIL key components

Missile Electronics

- Guidance Processing Unit
 - Generate elevator angle demands
 - Simultaneously roll stabilise missile nose
- Fin Control Actuation System
 - Implement fin control algorithms

System Emulators

- Laser Information Field emulator
 - Provides missile with its position
- Inertial Measurement Unit emulator
 - Provides missile with rates and accelerations for inertial reference calculations

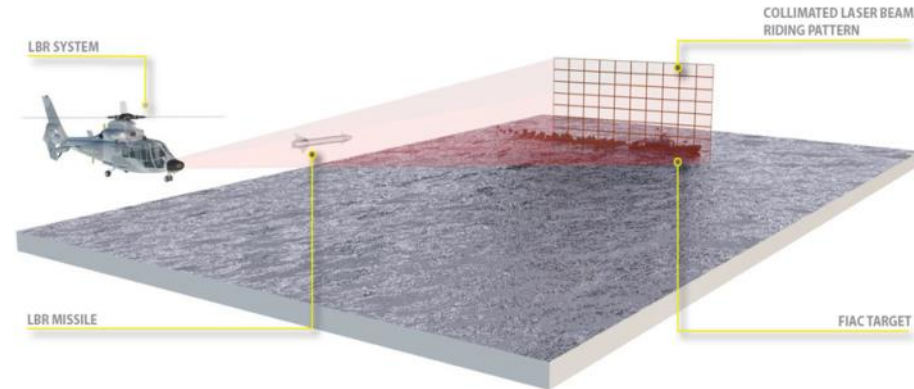
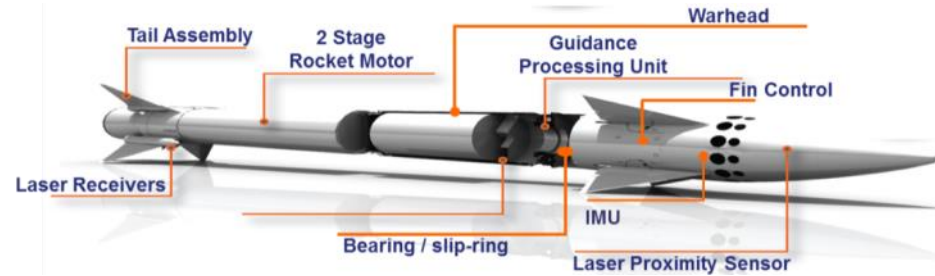

Hardware in the Loop (HIL) testing

- Autocoded algorithms implemented on hardware
- Simulink Real Time version of 6DOF simulation created
 - May require simplification - Larger step-size, remove high frequency dynamics, limit real time comms
- Model subsystems can be gradually removed from the 6DOF simulation and replaced with hardware or hardware emulators
- Run Monte-Carlo real time simulations on real time target
- Simulation version of algorithms can run on real time target in parallel to permit debugging

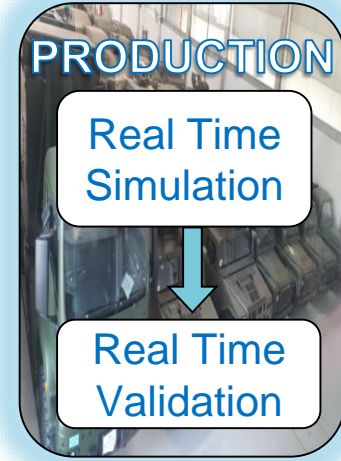

LMM Laser Beam Riding (LBR) HIL simulation

Close guidance loop with either:

- Fin deflections from actual missile hardware
- Fin deflections from real time 6DOF simulation

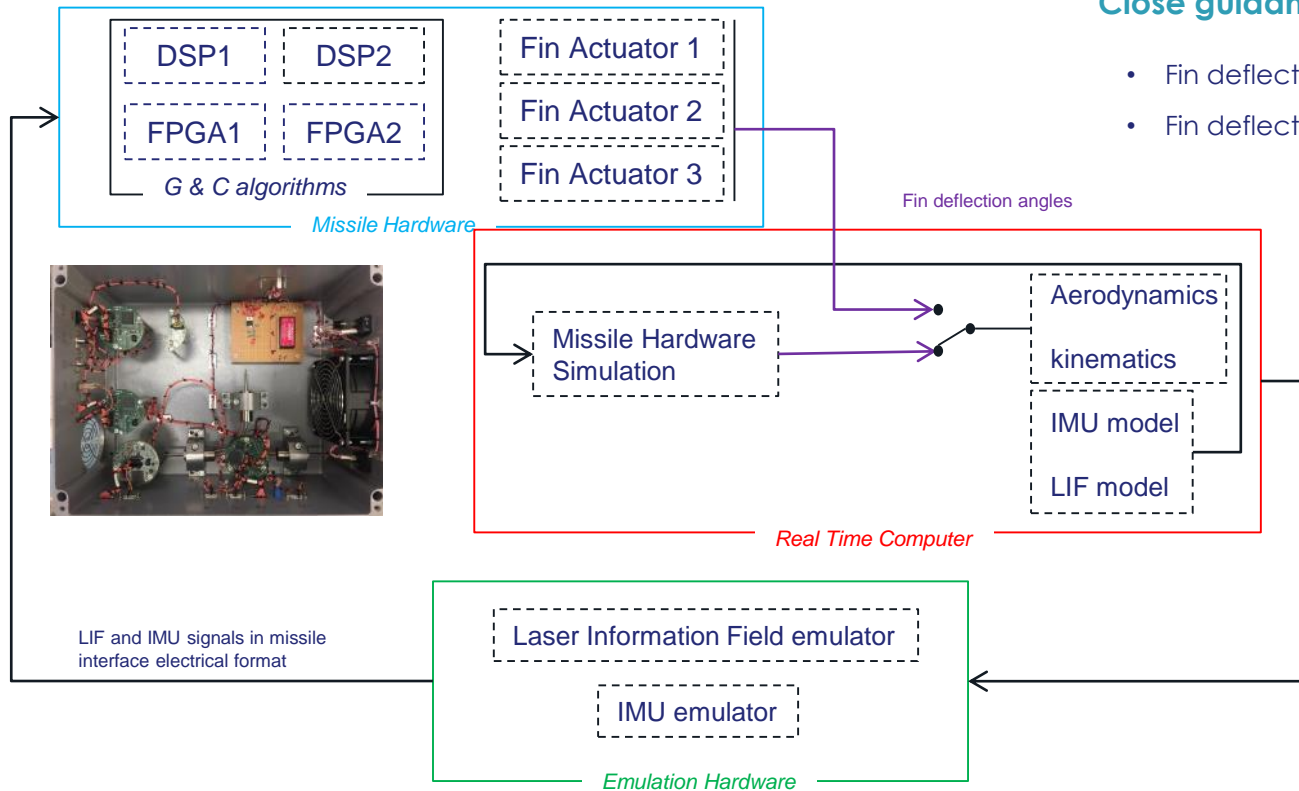

OPEN

Verification and validation

- HIL simulation is a key part of pre-flight tests
- Hardware stimulated closed-loop with realistic flight data
- Failure mode testing
- Iterative development – 6DOF (both non-real time and real time) validated against flight telemetry data
- Linkage from algorithm design model to hardware implementation tests accelerates rapid prototyping development and testing

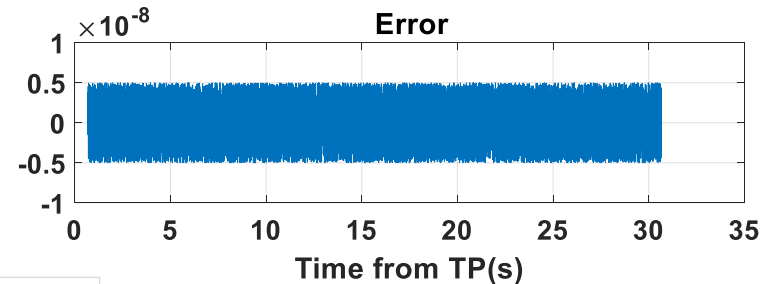
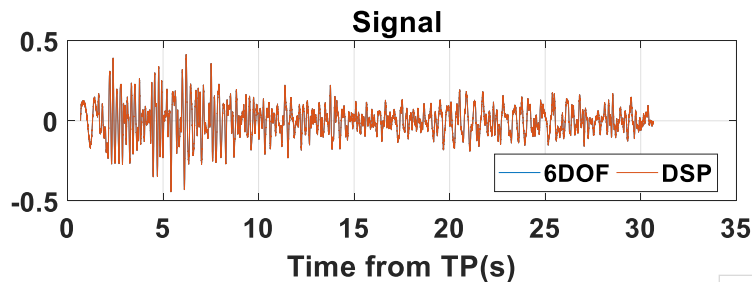

OPEN

Next steps

Missile Hardware



Real Time Computer

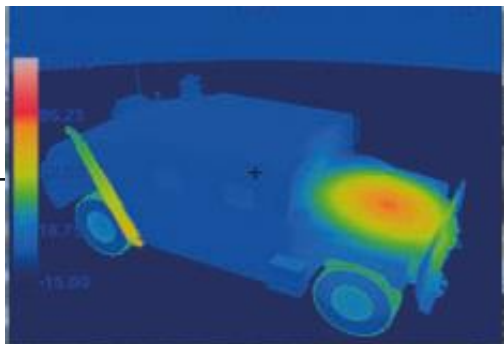

Real Time Sensor Emulation

Real Time Scenario Generation

OPEN

THALES

Goals and Objectives

- Remove human error
- Reduced code development time
- Early prototype on hardware
- Improved efficiency
- Fast turn around between iterations
- Common test environment
- Improved traceability



LMM in action

This document may not be reproduced, modified, adapted, published, translated, in any way, in whole or in part or disclosed to a third party without the prior written consent of Thales - © Thales 2017 All rights reserved.



OPEN